

FOS-13 / FOS-19 i n s t a l l a t i o n g u i d e



We congratulate you on purchasing our company's fiber-optic termination box FOS-13 / FOS-19!

Wall mounting fiber termination box FOS-13 and FOS-19 are devised for fiber-optical cable termination and connection of end-user equipment to data transmission network.

We are producing two types of termination boxes – FOS-13 which is devised for SC type adapters and FOS-19 for Duplex-SC type adapters.

Adding of pigtails is possible either using welding 40 mm HSP (heat shrink protector) or using mechanical connector. Our termination box has fixators for both types of connectors. Termination box is devised for incoming optical cables up to 9mm diameter.

Incoming cable is fastened with two plastic cable ties. Inside of the termination box you can also find cable reel with fixators for fiber and pigtail as well. You can fix box to the wall by using two 4mm screws.

Wall mounting fiber termination box consists of two parts - the base where you can find fixators for incoming cable, cable reel, fixators for connectors, SC or Duplex-SC adapter and box lid. The last one is fixating to the bottom with elastic clips without any screw. For lid removing you need flat-head screwdriver. The lid exterior has place for box label. The box is made from white ABS plastic.

Bigger orders has place for negotiations about different colors.

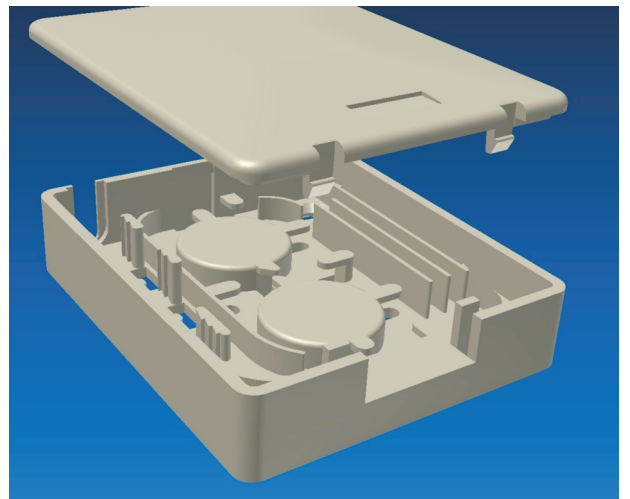

Technical specification:

Incoming cable up to 9 mm
One SC or one DuplexSC adapter
Dimensions 91.5*76.5*25 mm
Weight: about. 56 grams
Made from high-class ABS plastic

Installing sequence

1

Unpack termination box.

At the package you will find two body parts and two plastic cable ties 145 x 2.5 mm. Mount termination box on the wall using two 4 mm screws (not included in package).

2

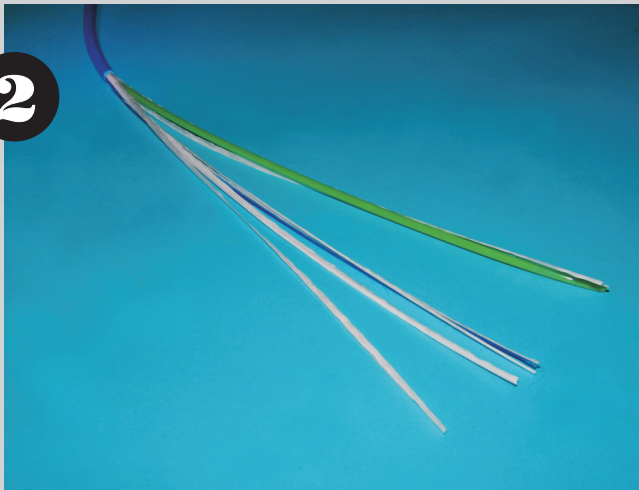

Prepare optical fiber.
Clean external isolation for approx. 30 cm.

3

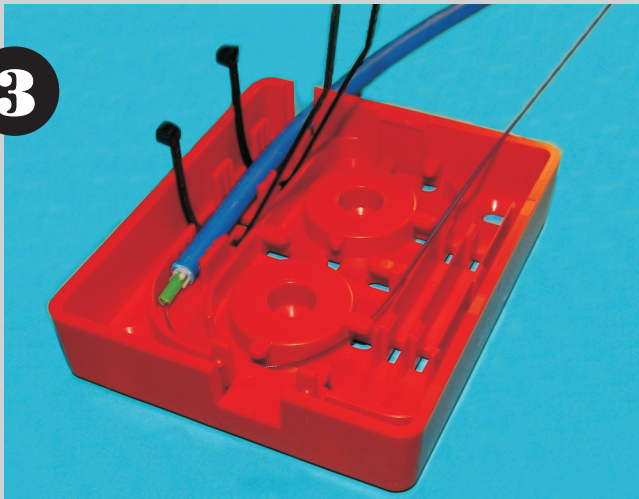

Fasten incoming cable with two plastic ties

4

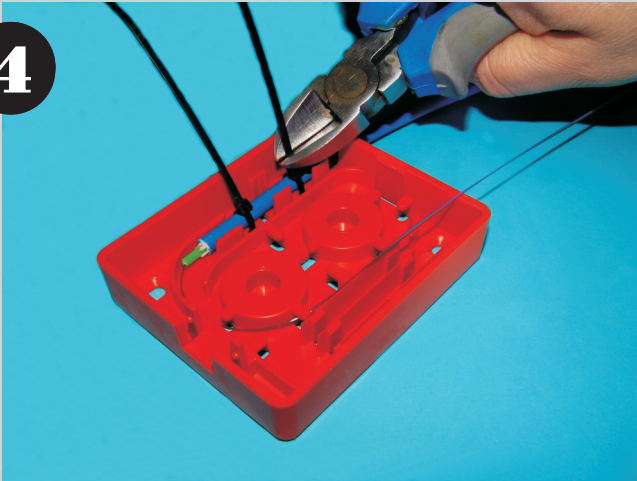

Cut off unneeded ends of plastic ties.

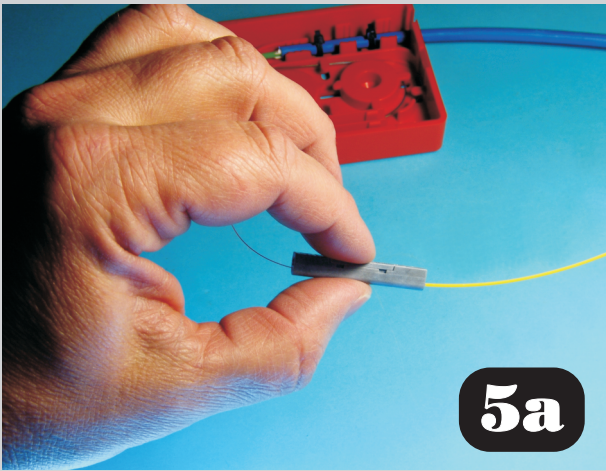

5a

In case of using mechanical splice holder do necessary connections in accordance with user manual.

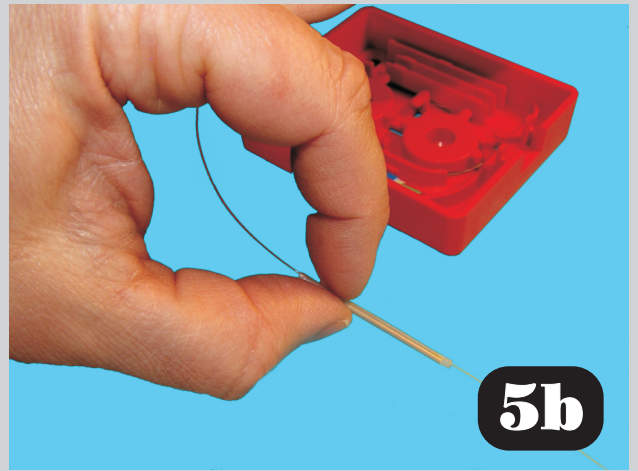

5b

In case of using HSP - do necessary welding in accordance with welding machine manual

warning !

Our termination box is designed only for 40 mm long HSP with 2.4 mm diameter in melted state.

Different HSP sizes may not fit in the termination box.

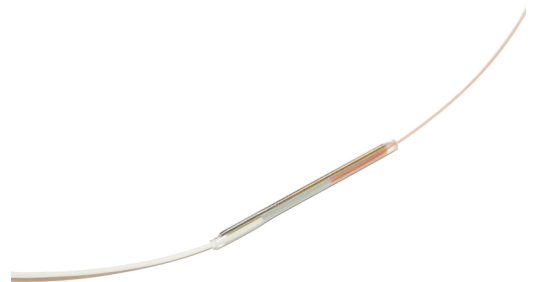

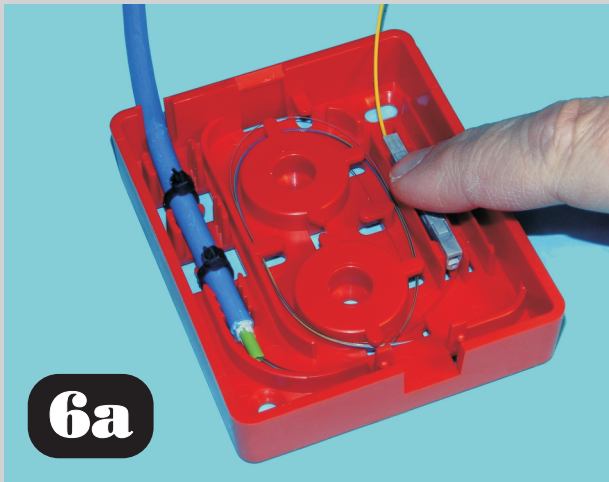

Fix the mechanical splice holder at devised place

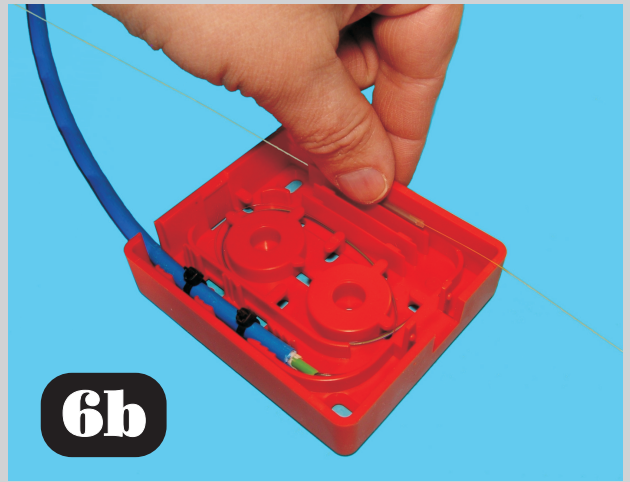

Fix HSP at devised place

Place optical fiber on reel.
NB! Avoid of sharp bending

7

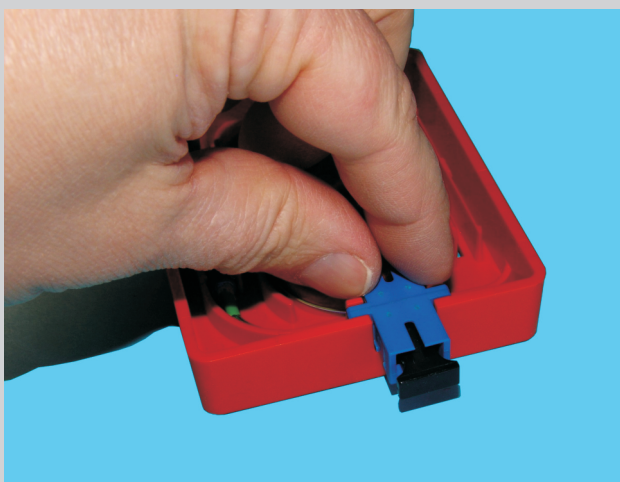
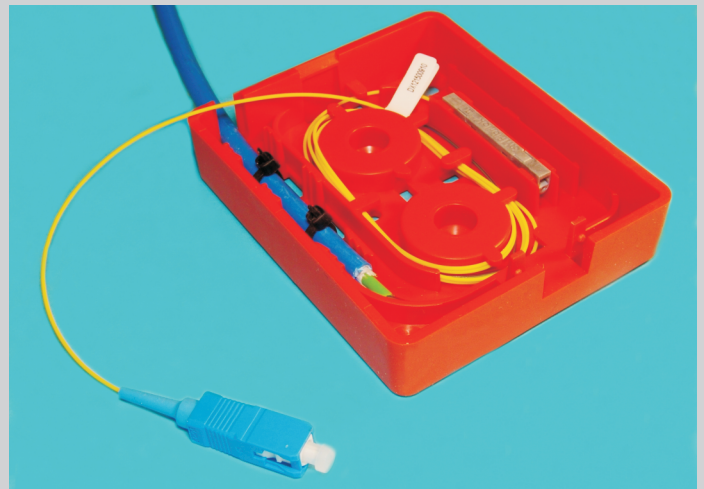

Fix SC adapter or Duplex-SC adapter at devised place

8

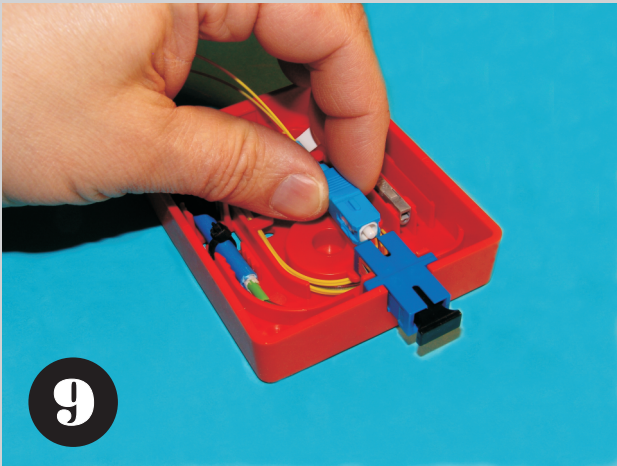

Plug patchcord into adapter

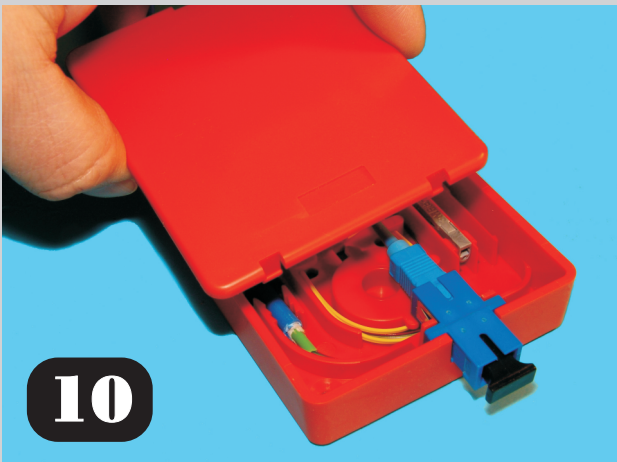

Force the lid till fixating

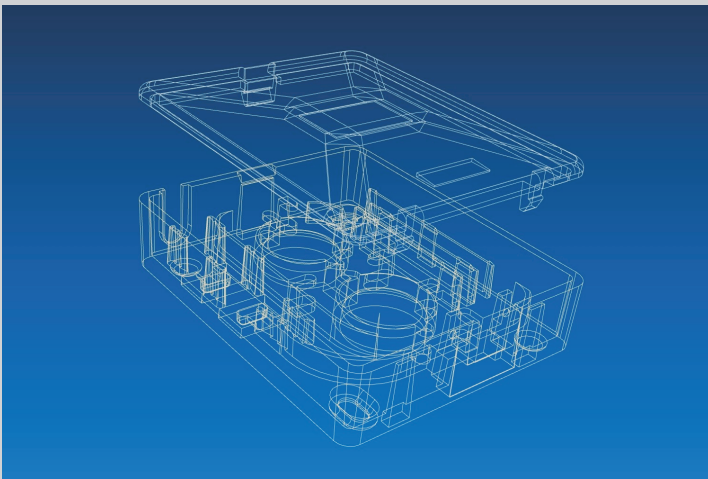

We are certain that following these mounting regulations, you will be able to make secure and compact optical cable installations!

Yours COMTECH.

